

Other IPv6 Experiments

ARIN Caribbean Sector Meeting

Mark Kusters

++Danny McPherson

++Randy Bush



**CARIBBEAN
SECTOR MEETING**

ARIN

Goal of Experiments

- Eat our own dog food (umm...)
- Is IPv6 practically usable?
- What improvements need to be made to make it practically usable?
- NANOG, APRICOT & IETF all recently conducted experiments to sample and foster usability
- AFNOG, RIPE, ARIN, AusNOG ... experimenting as well
- Goals more educational and documentary than demonstrative

The Enterprise Usage Model

- Consumers depends on ISPs, many models there
- ISPs for internal problem solving (e.g., Comcast model)
- Enterprises likely to be first ones who can NOT obtain new or additional IPv4 address space - either through RIR or their ISP
- Enterprises are more "controlled" environments
- They're YOUR customers :-)

**So what is it like to be an
Enterprise that can only
get IPv6 space?**

A Pure IPv6 Network Today...

- Would not get access to >99.9% of the 'net
- So you could see the dancing kame turtle (<http://www.kame.net>) and bouncing Google logo (<http://ipv6.google.com>)



- And you could have hit the 2008 Olympics "landing page" natively - but if you wanted results, you'd not have been able to see them.
- But not much else....
- Mainly because of **bits on the wire incompatibilities** with IPv4 and IPv6

A Pragmatic IPv6 LAN

Today

- An IPv6-only network with NAT-PT at the border and totd (DNS synthesis)
- Now we can get to the IPv6 world AND the IPv4 Internet
- See the dancing kame, bouncing 'Google', see Olympic results!
- This should work for UNIX, Linux, Mac, Vista, ...

NANOG/APRICOT IPv6 Network

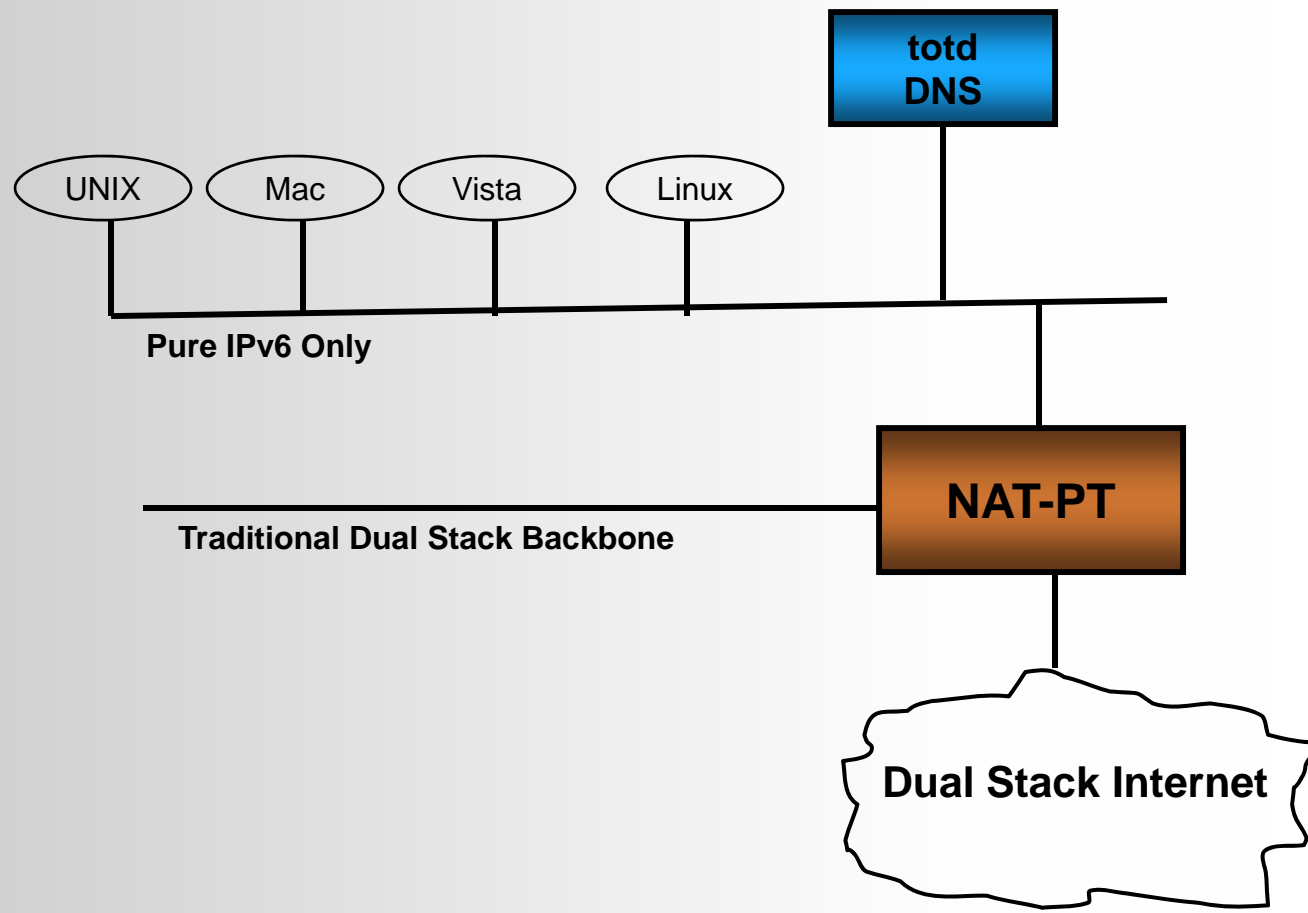

NAT-PT

- IPv6-only inside, dual-stack IPv4 and IPv6 on the other
- Stateful translation of TCP when no IP addresses are embedded
- ALGs needed for FTP, RTP, ... where Network layer addresses are embedded - e.g., layer violations occur - custom apps, etc..

The DNS Hack

- On a pure IPv6 network, if I get an A record (DNS RR records that maps to an IPv4 address), what do I do?
- Panic, you can't use an A record!
- So the local DNS cache has a hack, *tota*, which takes an A, embeds it within a hacked IPv6 prefix, and synthesizes an AAAA
- NAT-PT knows the hack prefix, and strips it back to IPv4 to dual-stack (and IPv6 was the answer to preserving e2e?)

TOTD - DNS Translation Proxy

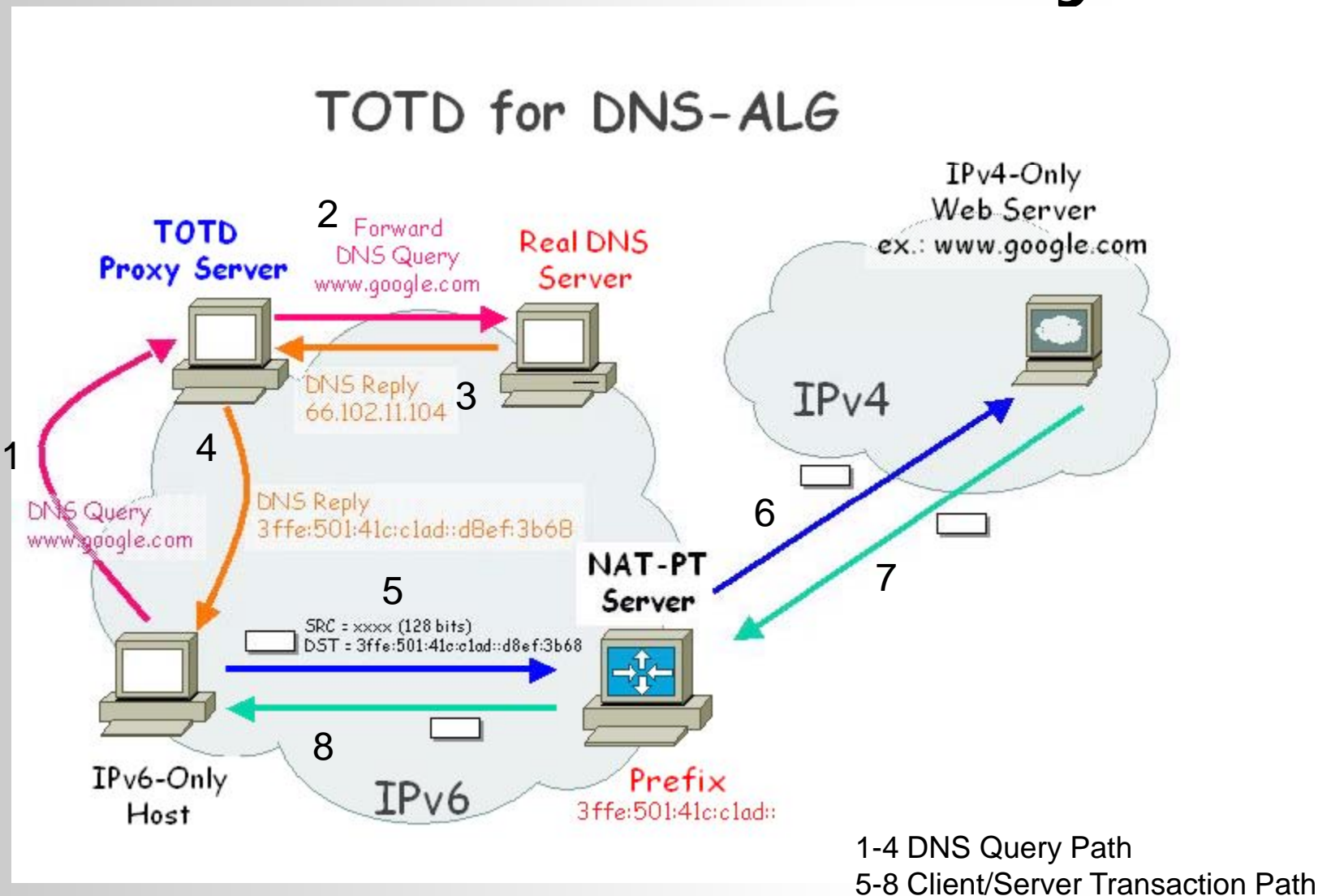

Diagram by Vasaka Visoottiviseth

<http://mucc.mahidol.ac.th/~ccvvs/totd-setup.html>

Windows XP

- XP can move payload over IPv6
- But does NOT do 'DNS' over IPv6 transport (nor AD, or other things! "MSFT: Buy Vista")
- So, the LAN has 1918 IPv4 space to carry DNS, but no exit for IPv4
- You get an IPv6 and IPv4 address, but should use the IPv6 for all real transport as IPv4 has no default
- Run a local resolver (e.g., BIND) that supports v6 on the client to hack around this

Modified Network

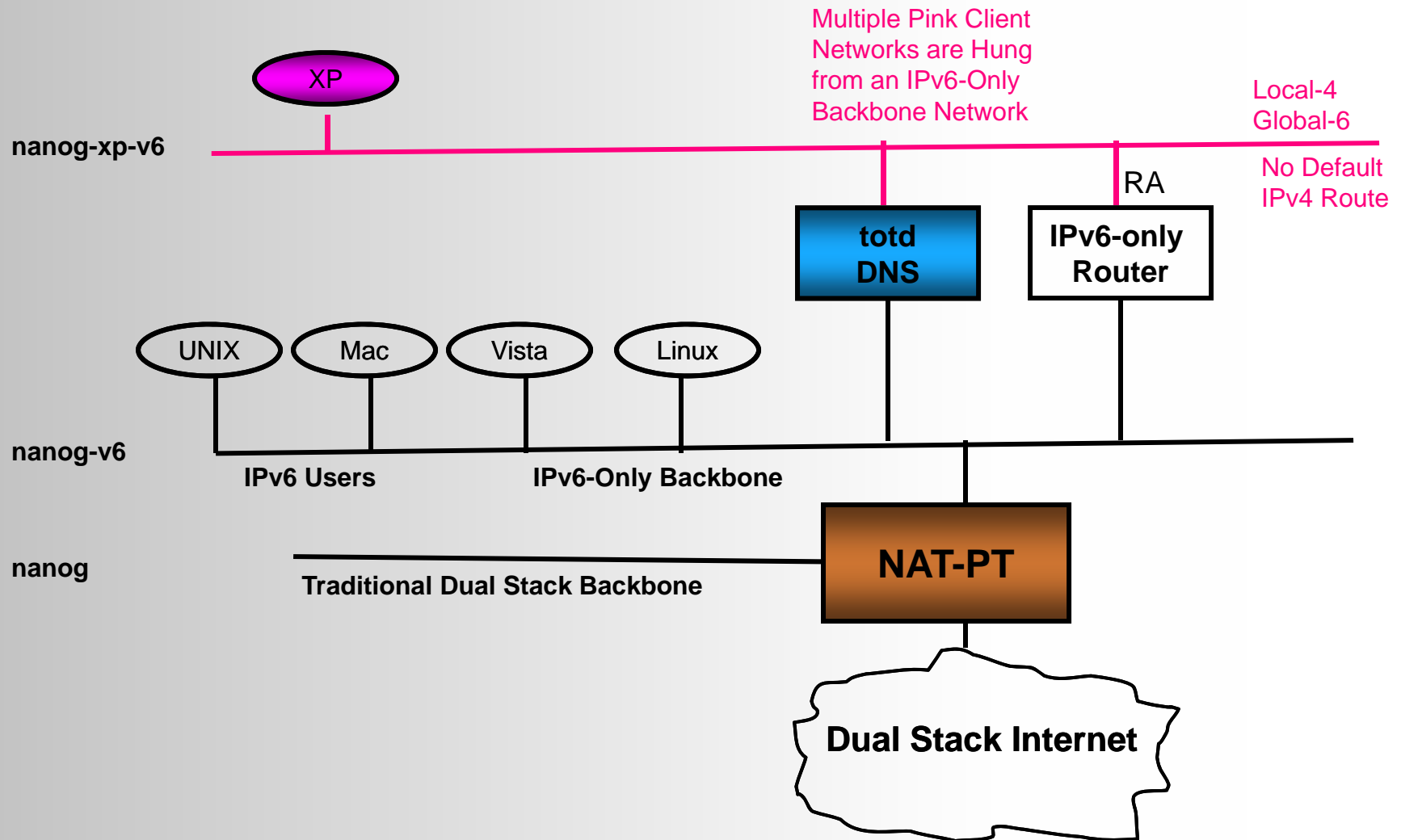

Access

- All SSIDs up from start
 - **nanog** normally fully dual-stack
 - **nanog-v6** with NAT-PT
 - **nanog-xp-v6** with 1918 DNS translation
- At APRICOT, for 90 minutes on Wednesday **apricot** went away, at NANOG for 60 minutes on Tuesday
- At NANOG some stats were gathered, none really collected at APRICOT

What We Learned

- 3/4 of users said they could not get on net but it was actually more like half
- Every component except UNIXes had bugs: NAT-PT, Vista, MacOS, XP, ...
- The prize to MacOS, which dropped capital 'A' from DNS server entry, among others
- We hope vendors now working to fix

NANOG MAC Address Stats

MAC address counts by VLAN at NANOG42; Data from Tuesday, Feb. 19 2008
(times corrected to PST)

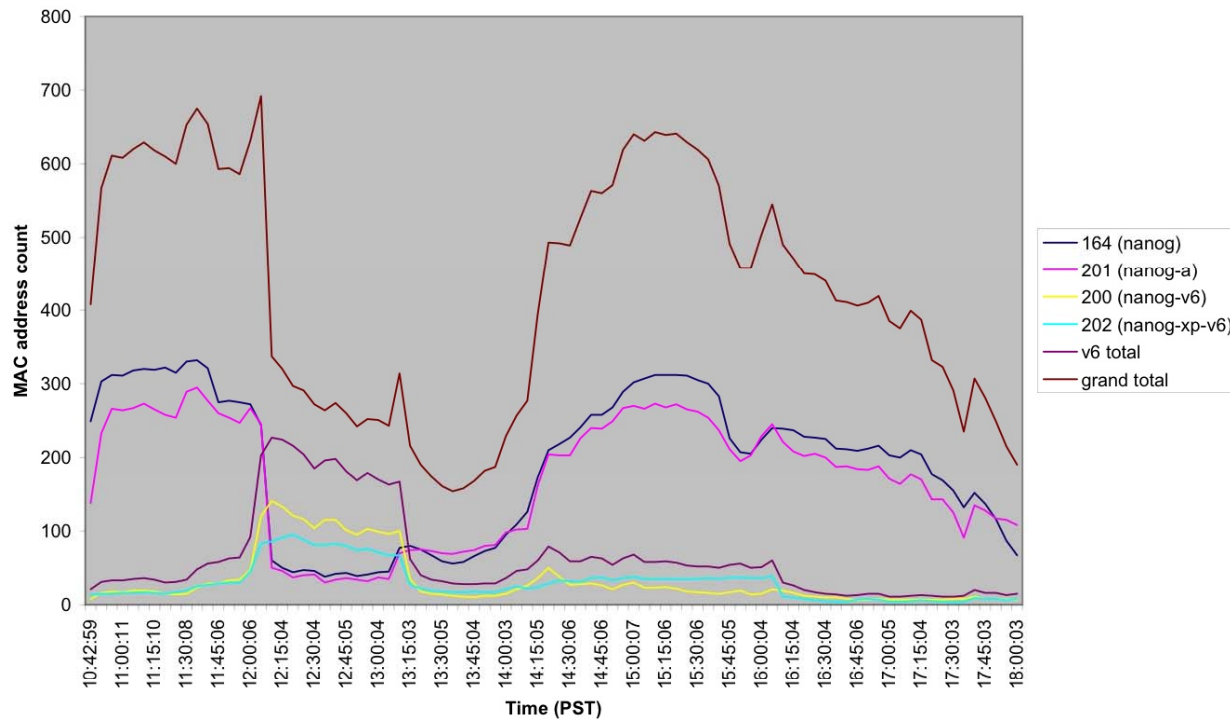

IETF 71 Experiment

- Held during IESG plenary session on Wednesday evening
- Already learned much from NANOG and APRICOT experiments
- No NAT-PT - would have been ironic considering recent move of NAT-PT specification to historic
- Dual-stack, v6-only, and 464-nat networks

Other IETF observations..

- Some observations..
 - No workie:
 - iTunes Store
 - Apple Bug Reporter
 - Skype
 - iPhone no IPv6 capabilities
 - Jabber (server issues with OpenFire per html v. txt transcripts, Adium client seemed OK - though many IM servers not reachable - e.g., google talk - though translators made available)
 - iChat will only work if there's still an IPv4 address on the system somewhere
 - www.ripe.net worked, but not others such as lirportal.ripe.net and ris.ripe.net
 - www.apple.com
 - jabber.psg.com had no AAAA records, although there is a www.psg.com one. Exists now :-)

IETF Experiment

Notables

- There was a power outage just before the IPv6 outage - some speculate it was over IPv4...
- ipv6.google.com launched
 - Local stuff worked
 - Not much else
- Mark Andrews provided BIND fix for Windows XP to mitigate native DNS resolution issue (i.e., run local bind resolver)
- All IETF Web sites worked
- Made /. - “The Night the IETF Shut Off IPv4”
- /. not reachable via IPv6

Double NAT - v4v6v4

- Double NAT model to accommodate
- Described in
 - draft-durand-v6ops-natv4v6v4-01.txt
- Distributed NAT model where globally routed v4 addresses are shared among a pool of users
- MTU & ALG considerations
- Still very much research

How You Can Play

- <http://www.civil-tongue.net/6and4/>
- Has instructions for platforms
- Has instructions how to turn it back off when you go home!
- Is a wiki, so .. If you want to play:
 - Create a login ID, open a ticket and request editor privileges
 - You can also use tickets to report problems, send feedback, etc..
 - Share your experiences

Miscellany...

- NAT-PT is nasty, but with no bits on the wire compatibility, necessary
- Transition == co-existence for a long time
- Ubiquitous dual-stack no-opt at this stage
- End 2 end transparency will be further compromised, your packets will be more molested as a result
- IPv4 exhaustion is imminent, IPv6 deployment necessary

An Unanticipated Benefit...

- There has never existed a formally verifiable mechanism for authentication of address space allocations (i.e., IANA->RIR-LIR/ISP->)
- Because of concerns of IPv4 trading model, RIRs are developing model based on RPKI and SIDR work
- Provides infrastructure for seeding IRR route objects, providing repository source for secure routing, either out of band, or down the road integrated into routing protocols (e.g., SoBGP or SBGP)

IETF Bits

- IETF moved NAT-PT specification to historic status, citing 20+ concerns (e.g., transparency, external concerns such as DNS, etc..)
- Left gaping hole - no bits on wire compatibility
- Much work still happening in this area
- IAB plenary at IETF 72:
 - <https://datatracker.ietf.org/meeting/72/materials.html>
 - Search for "PLENARYW"
- If you want to get engaged:
 - <http://www.ietf.org/html.charters/v6ops-charter.html>

IPv6 Traffic Distribution

- ASNs with IPv6 BGP Announcements: 3%
- Internet2 sites with passing IPv6 Grade: 1%
- Alexa Top 500 websites IPv6-enabled: 0.4%
- IPv6 DNS queries as % of total: 0.2%
- **IPv6 percentage of all Internet traffic: 0.0026%**

IPv6 as Percentage of IPv4 Internet Traffic

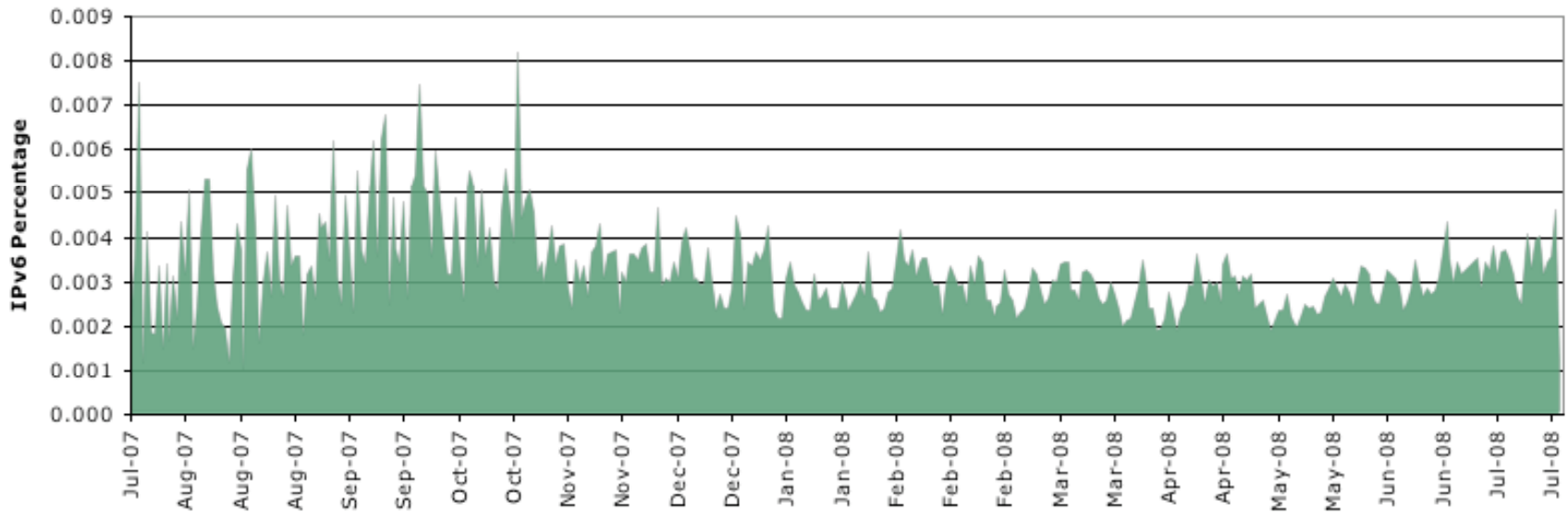

Aggregate IPv6 Traffic

- Since July 2007, IPv6 traffic has grown by nearly a factor of 5 to an average of 100 Mbps per day.
- BGP tables show an even larger proportional growth. Though not a landslide of adoption, it is still something.

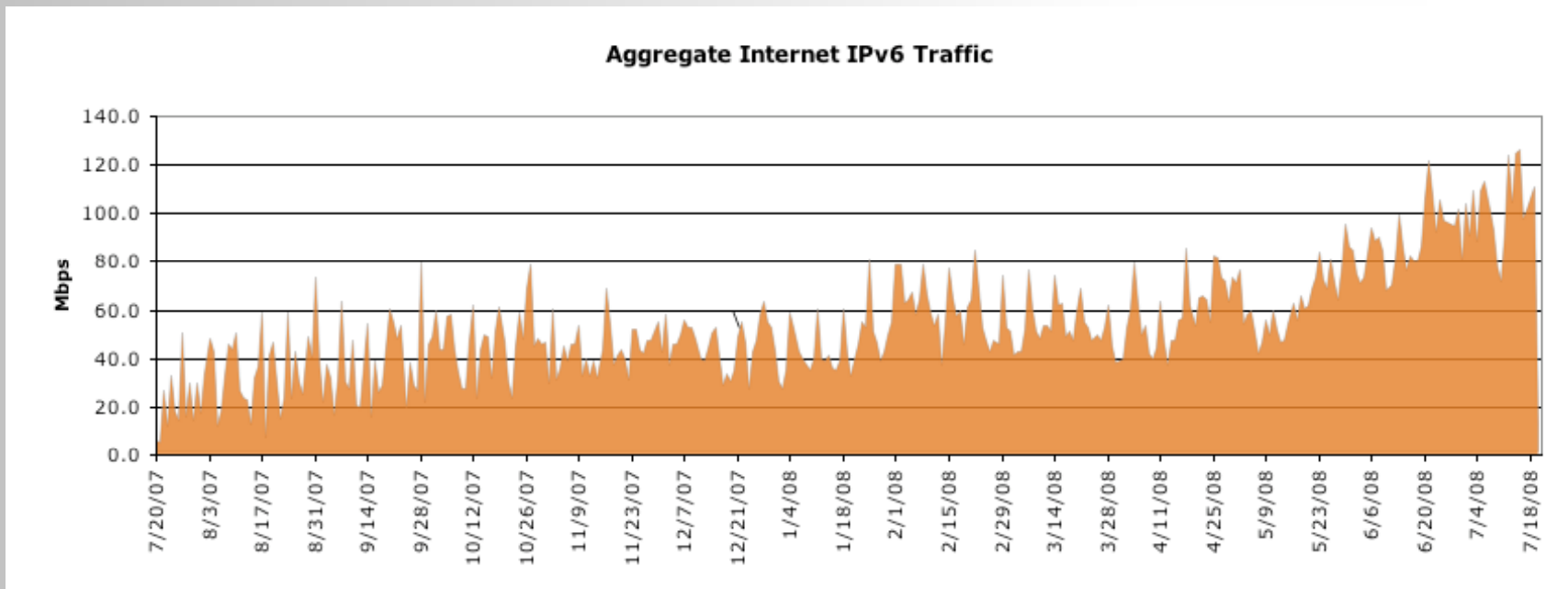

Teredo, Port Obfuscation, etc..

- If port obfuscation or related techniques are employed we're held captive to that, as our observations *here* are based solely on Network and Transport layer data
- Teredo traffic upticks have been observed, new chart as of yesterday below. If not using well-known ports - well, yes, we realize that's not reported
- Only 14 deployments have observed any port 3544 control traffic, and of those only two saw a significant amount. The rest saw only kbps, and had weeks of none subsequently
- Some observable upticks as a result of new software releases, industry events, etc.. (e.g., uTorrent, IETF)
- IPv6 here still miniscule compared to aggregate

Aggregate IPv6 Teredo (port 3544)

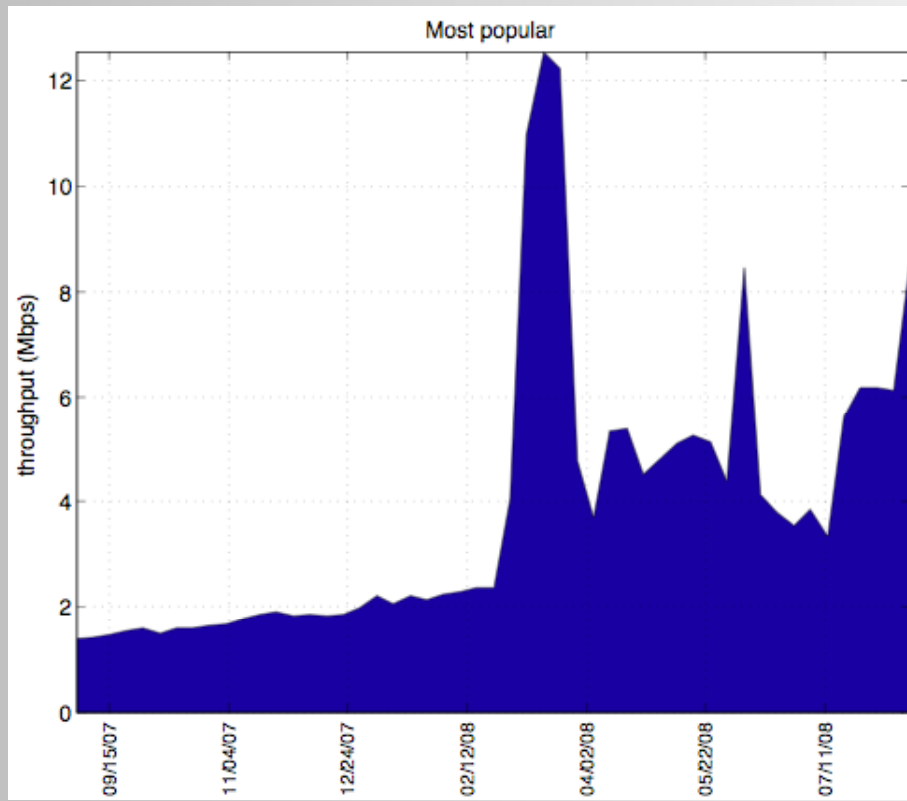

Teredo

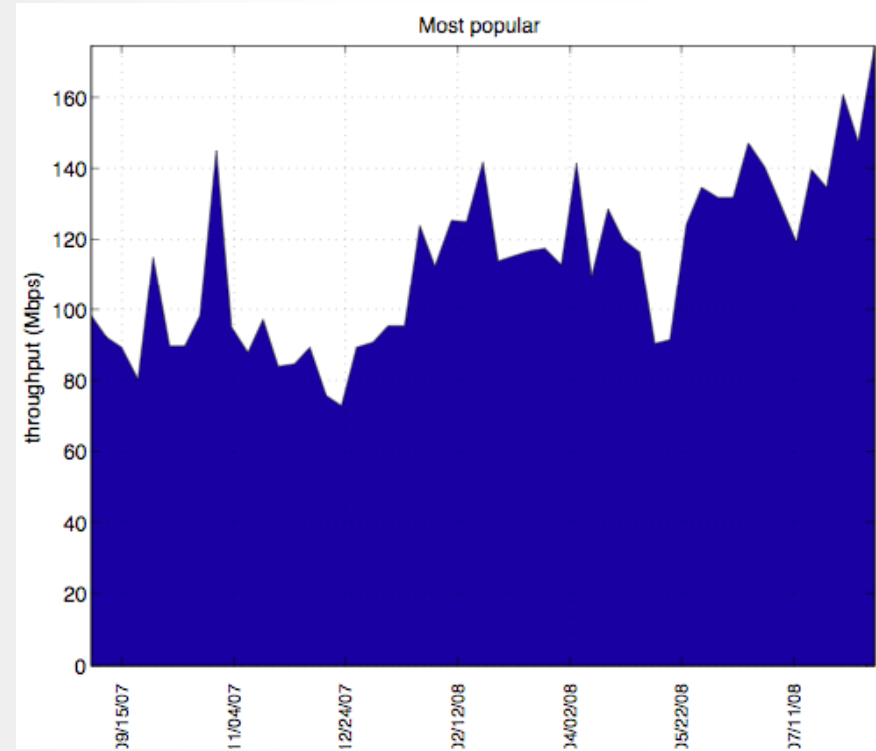

IPv6 (native & tunneled)

Thanks To....

- Chung-Hwa Telecom, MERIT & Comcast
- Philip Smith, Lucy Lynch, Joel Jaeggli
- IJ & ISOC
- Cisco & Philip Smith
- APRICOT, NANOG & IETF Sponsors
- And Philip Smith...